

NB : V1(\*1,\*2), V2(\*1,\*2) : LED BICOLORE PLCC 3500 K / 1200 mcd  
 V3 : LED BLANCHE 1206 3500 K / 500 mcd  
 H1...H6 : LED BLANCHE PLCC 2800 K / 1200 mcd

AVANT

ARRIERE

OUTC	VERT
RAIL D	ROUGE
MOT D	ORANGE
V+	BLEU
OUTA	BLANC
OUTB	JAUNE
MOT G	GRIS
RAIL G	NOIR

DECODEUR LENZ STANDARD+

CONNECTEUR PAS 1.27

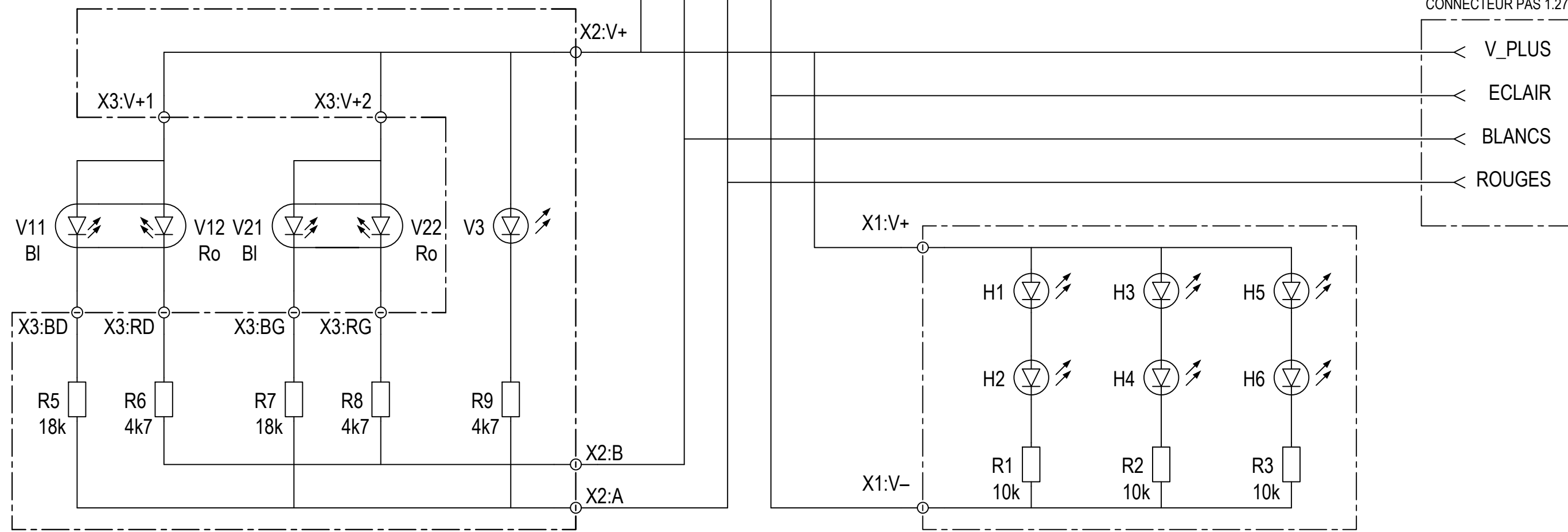

FEU AV DROIT

FEU AV GAUCHE

FEU FRONTAL

ECLAIRAGE COMPARTIMENTS

FICHER	RGP_schema_circuits
AUTEUR	GUILLOTIN
DATE	10-10-2015 à 00h

REVISION	INDICE ORIGINAL
	AUTEUR
	DATE

**RGP TEE ROCO**  
 CABLAGE DE LA MOTRICE

PLAN N°	XXXXX
FOLIO N°	01/03

AVANT (VERS MOTRICE)

ARRIERE (VERS CABINE)

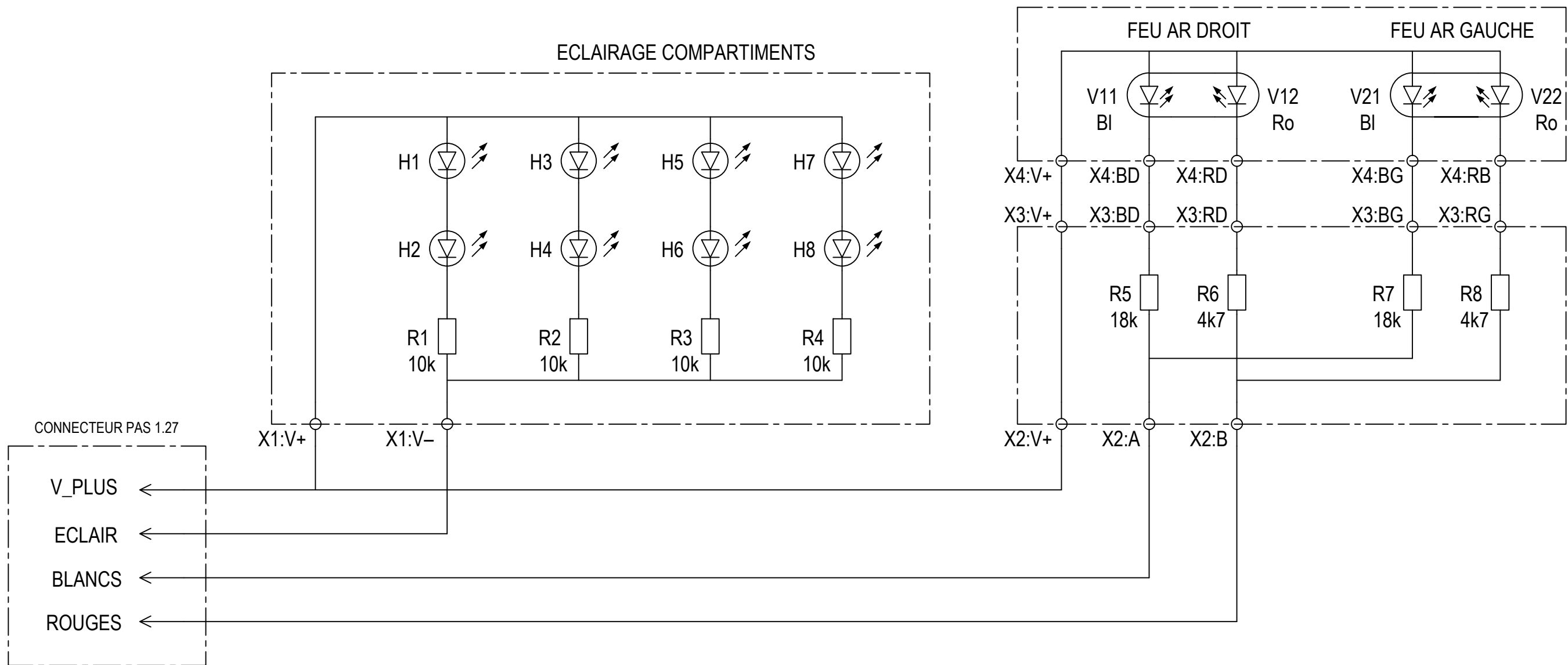

FICHER	RGP_schema_circuits
AUTEUR	GUILLOTIN
DATE	10-10-2015 à 00h

REVISION	INDICE ORIGINAL
	AUTEUR
	DATE

**RGP TEE ROCO**  
 CABLAGE DE LA REMORQUE

PLAN N°	XXXXX
FOLIO N°	02/03

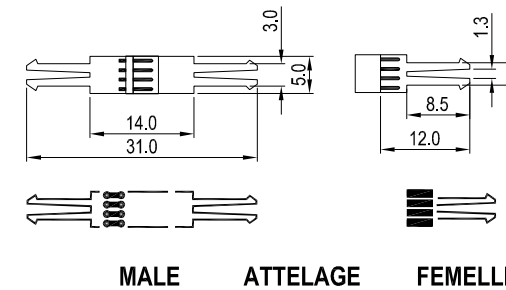
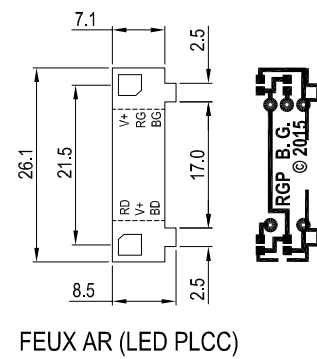
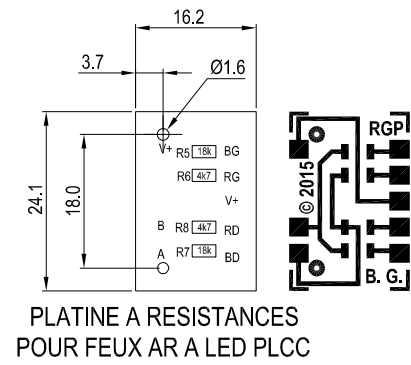
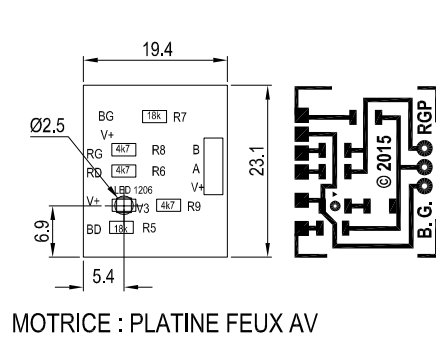
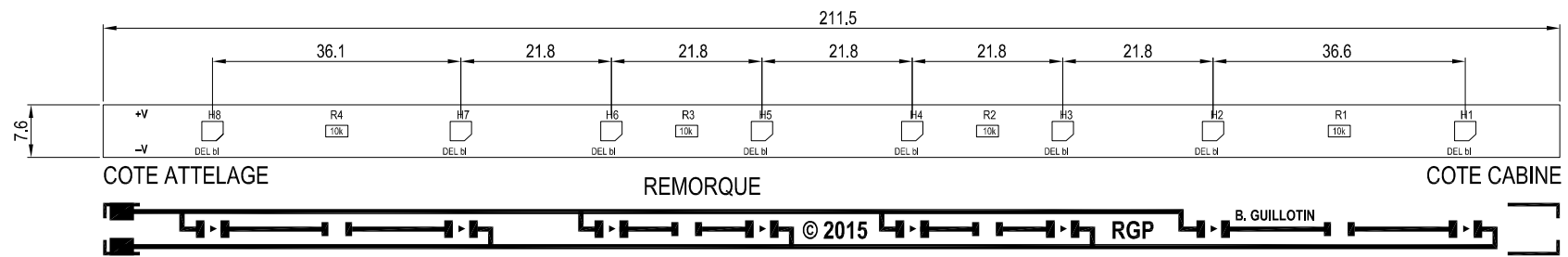
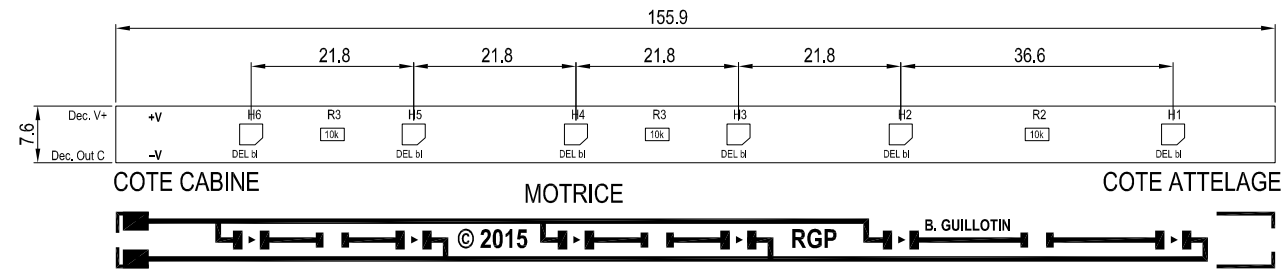

FICHER RGP\_schema\_circuits  
AUTEUR GUILLOTIN  
DATE 10-10-2015 à 00h

REVISION	INDICE ORIGINAL
	AUTEUR
	DATE

# RGP TEE ROCO

## CIRCUITS IMPRIMES

PLAN N° XXXXX  
FOLIO N° 03/03